



■ Features :

- Universal AC input / Full range
- No load power consumption < 0.3W
- Energy efficiency Level V
- Comply with EU ErP
- 2 pole EURO plug
- Class II power (without earth pin)
- Protections: Short circuit / Overload / Over voltage / Over temperature
- Pass LPS
- Fully enclosed plastic case
- 2 years warranty



SPECIFICATION

ORDER NO.	GS12E05-P1I	GS12E07-P1I	GS12E09-P1I	GS12E12-P1I	GS12E15-P1I	GS12E18-P1I	GS12E24-P1I	
OUTPUT	SAFETY MODEL NO.	GS12E05	GS12E07	GS12E09	GS12E12	GS12E15	GS12E18	GS12E24
	DC VOLTAGE	5V	7.5V	9V	12V	15V	18V	24V
	RATED CURRENT	2.0A	1.6A	1.33A	1.0A	0.8A	0.67A	0.5A
	CURRENT RANGE	0 ~ 2.0A	0 ~ 1.6A	0 ~ 1.33A	0 ~ 1.0A	0 ~ 0.8A	0 ~ 0.67A	0 ~ 0.5A
	RATED POWER	10W	12W	12W	12W	12W	12.06W	12W
	RIPPLE & NOISE (max.) Note.2	75mVp-p	90mVp-p	90mVp-p	120mVp-p	150mVp-p	180mVp-p	200mVp-p
	VOLTAGE TOLERANCE Note.3	±5.0%	±4.0%	±4.0%	±3.0%	±3.0%	±3.0%	±3.0%
	LINE REGULATION Note.4	±1.0%	±1.0%	±1.0%	±1.0%	±1.0%	±1.0%	±1.0%
	LOAD REGULATION Note.5	±5.0%	±4.0%	±4.0%	±3.0%	±3.0%	±2.0%	±2.0%
SETUP, RISE, HOLD UP TIME	500ms, 20ms, 30ms/230VAC 500ms, 20ms, 10ms/115VAC at full load							
INPUT	VOLTAGE RANGE	90 ~ 264VAC		135 ~ 370VDC				
	FREQUENCY RANGE	47 ~ 63Hz						
	EFFICIENCY (Typ.)	76%	78.5%	78.5%	78.5%	80%	80%	80.5%
	AC CURRENT	0.31A / 115VAC		0.16A / 230VAC				
	INRUSH CURRENT (max.)	COLD START 25A / 115VAC		45A / 230VAC				
LEAKAGE CURRENT (max.)	0.25mA / 240VAC							
PROTECTION	OVERLOAD	>105% rated output power Protection type : Hiccup mode, recovers automatically after fault condition is removed						
	OVER VOLTAGE	115% ~ 135% Protection type : Clamp by zener diode						
	OVER TEMPERATURE Note.6	U1 Tj 140°C typically (U1) Detect on main control IC Protection type : Shut down o/p voltage, recovers automatically after temperature goes down						
ENVIRONMENT	WORKING TEMP.	0 ~ +50°C (Refer to "Derating Curve")						
	WORKING HUMIDITY	20% ~ 90% RH non-condensing						
	STORAGE TEMP., HUMIDITY	-20 ~ +85°C, 10 ~ 95% RH						
	TEMP. COEFFICIENT	±0.03% / °C (0 ~ 40°C)						
	VIBRATION	10 ~ 500Hz, 2G 10min./1cycle, period for 60min. each along X, Y, Z axes						
SAFETY & EMC	SAFETY STANDARDS	TUV EN60950 -1 approved						
	WITHSTAND VOLTAGE	I/P-O/P:3KVAC						
	ISOLATION RESISTANCE	I/P-O/P:100M Ohms / 500VDC / 25°C / 70% RH						
	EMC EMISSION	Compliance to EN55032 class B, EN61204-3, EN61000-3-2,3, FCC part15 class B						
	EMC IMMUNITY	Compliance to EN61000-4-2,3,4,5,6,8,11, EN61204-3, light industry level, criteria A						
OTHERS	MTBF	1414.6Khrs min. MIL-HDBK-217F (25°C)						
	DIMENSION	65*47*26.5mm (L*W*H)						
	PACKING	0.15Kg ; 100pcs / 16Kg / CARTON						
CONNECTOR	PLUG	See page 2 : Other type available by customer requested						
	CABLE	See page 2 : Other type available by customer requested						
NOTE	<p>1.All parameters are specified at 230VAC input, rated load, 25°C 70% RH ambient.</p> <p>2.Ripple & noise are measured at 20MHz by using a 12" twisted pair terminated with a 0.1uf & 47uf capacitor.</p> <p>3.Tolerance: includes set up tolerance, line regulation, load regulation.</p> <p>4.Line regulation is measured from low line to high line at rated load.</p> <p>5.Load regulation is measured from 10% to 100% rated load.</p> <p>6.The over temperature protection (OTP) is the built-in function of the control IC (U1). The activating level described above is based on the specification provided by the IC manufacturer.</p>							

■ Mechanical Specification

Unit:mm

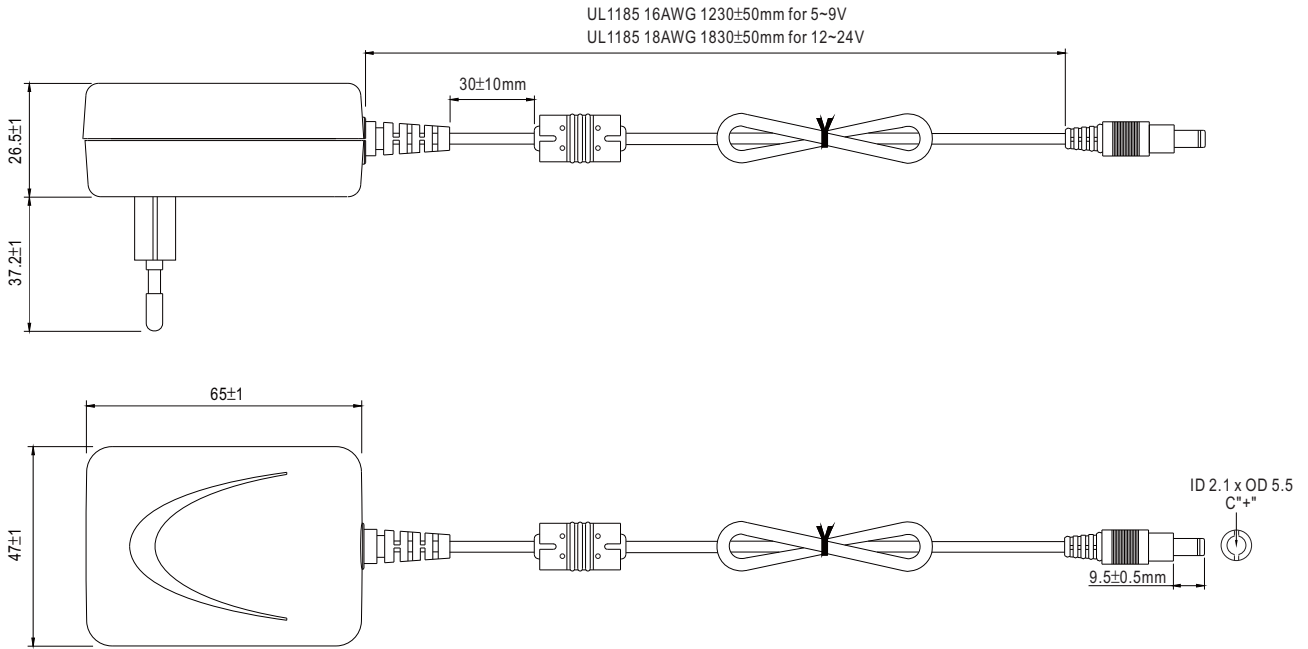

■ Plug Assignment

Standard plug: P1I

P1I	
P/N	OUTPUT
CENTER	+

■ Derating Curve

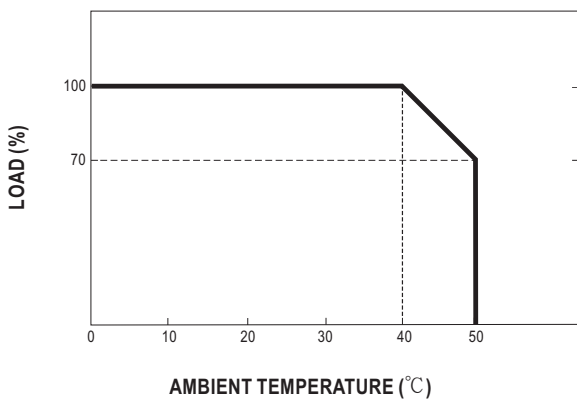

■ Static Characteristics(24V)

